

THESE CONNECTIONS ARE FOR INSTRUMENTATION PANEL

TO AIR CONDITIONING UNIT

UNITS

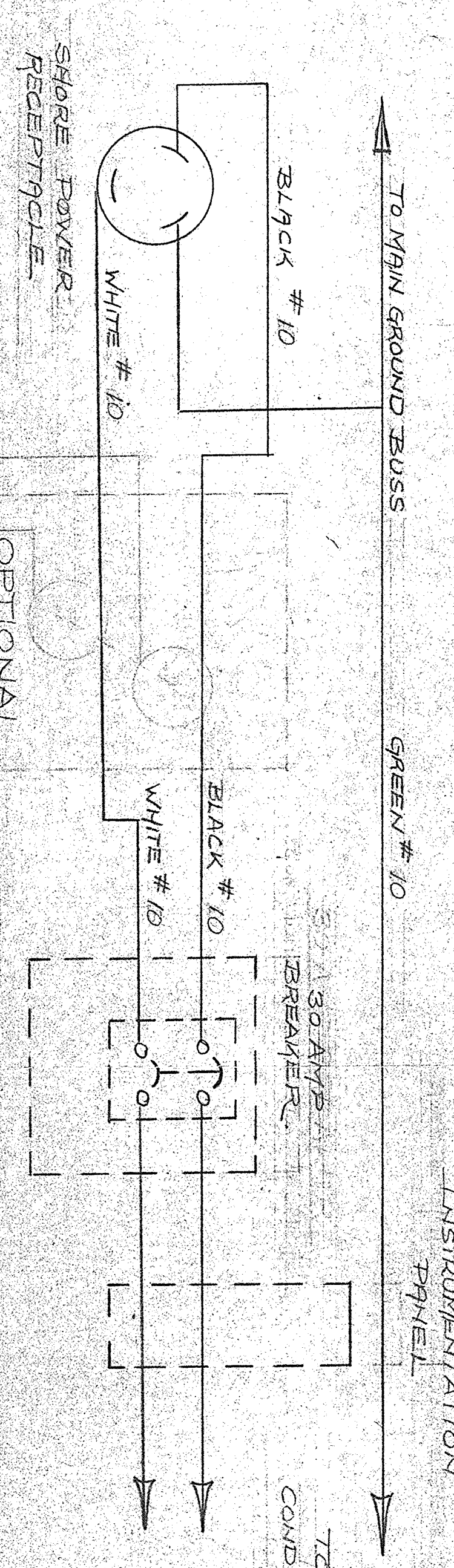

TO MAIN GROUND BUS

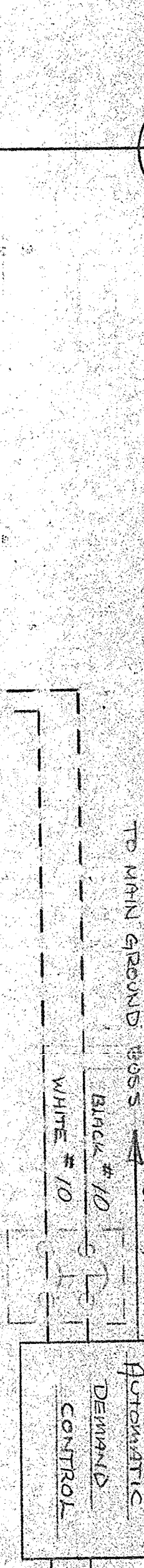
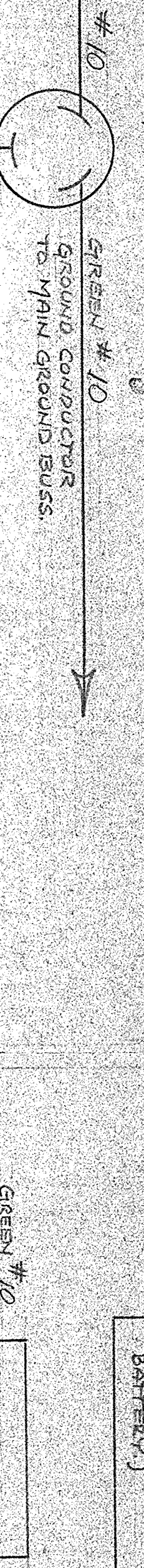

D.C. MASTER CONTROL PANEL  
FUSES, VOLT METER AND BATTERY TEST SWITCH AS STANDARD

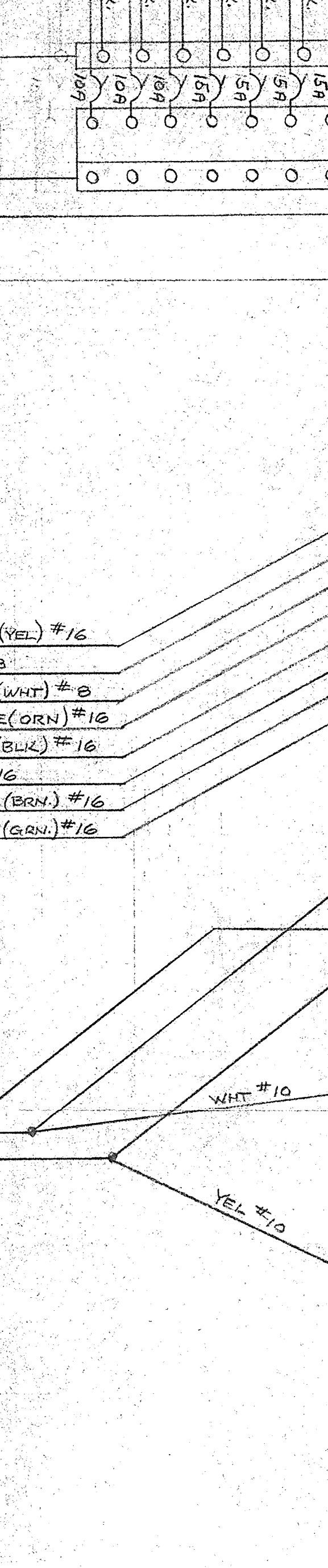

AC MASTER CONTROL PANEL  
OPTIONAL 4-1/2 AMP. DOUBLE-TAPPED AND 4-1/2 AMP. W/OUT TAPPED

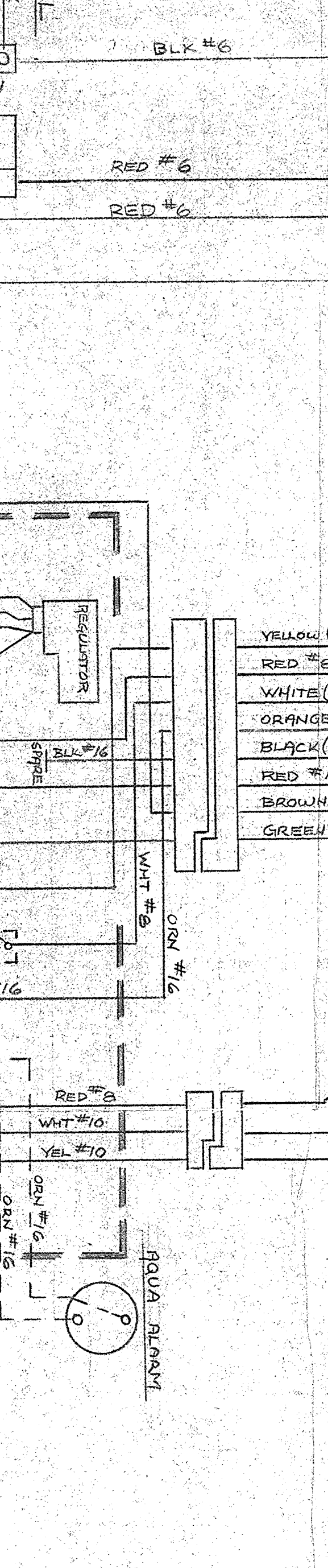

BATTERY BANK  
(TWO 105 AMP BATTERIES)

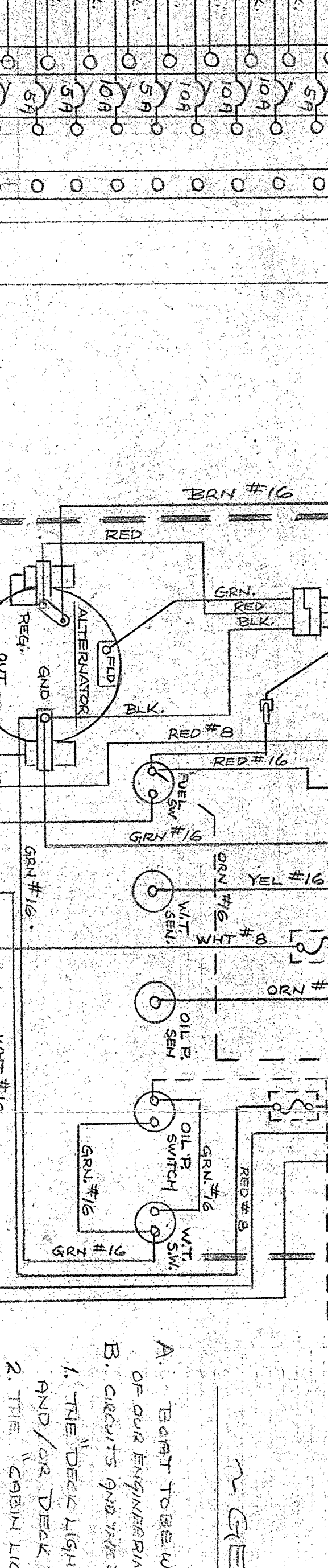

OPTIONAL CONVERTER  
(OPTIONAL R-40 SPOON)

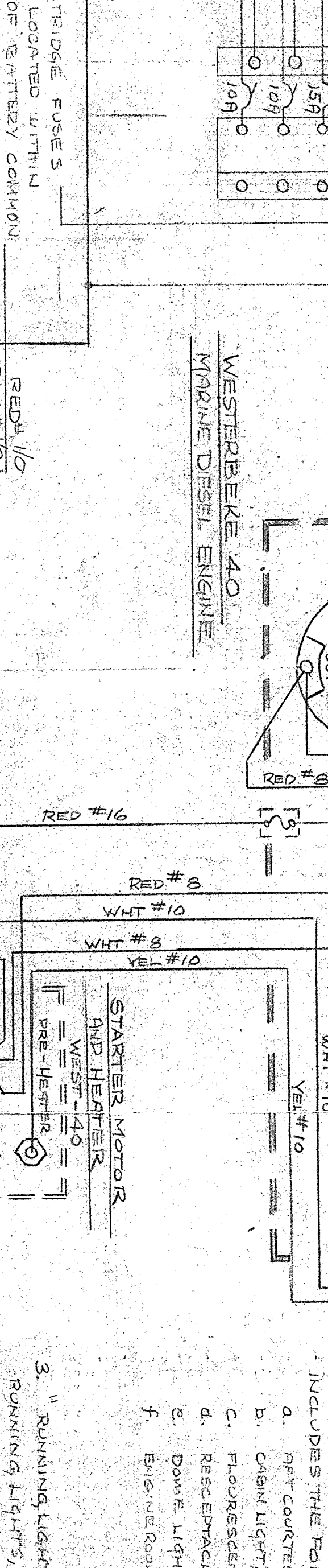

INSIDE STEERING STATION

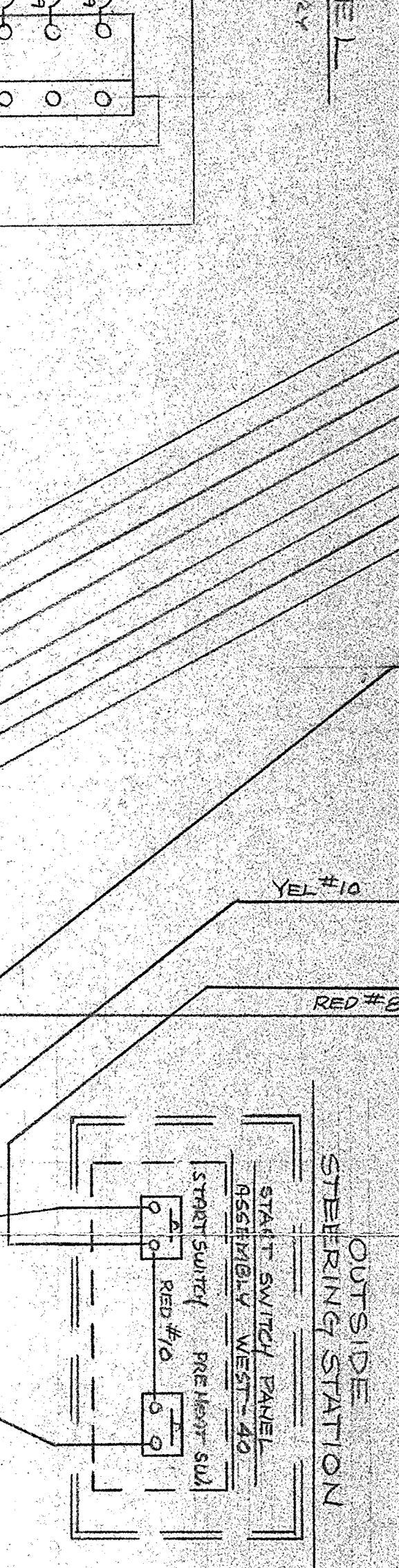
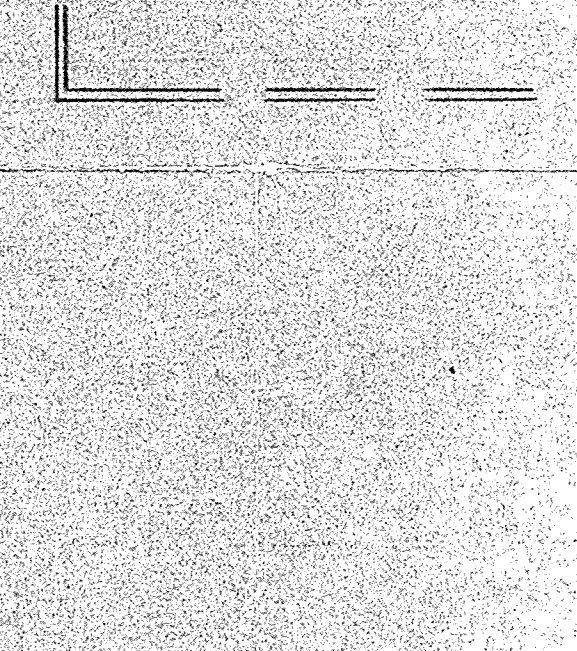
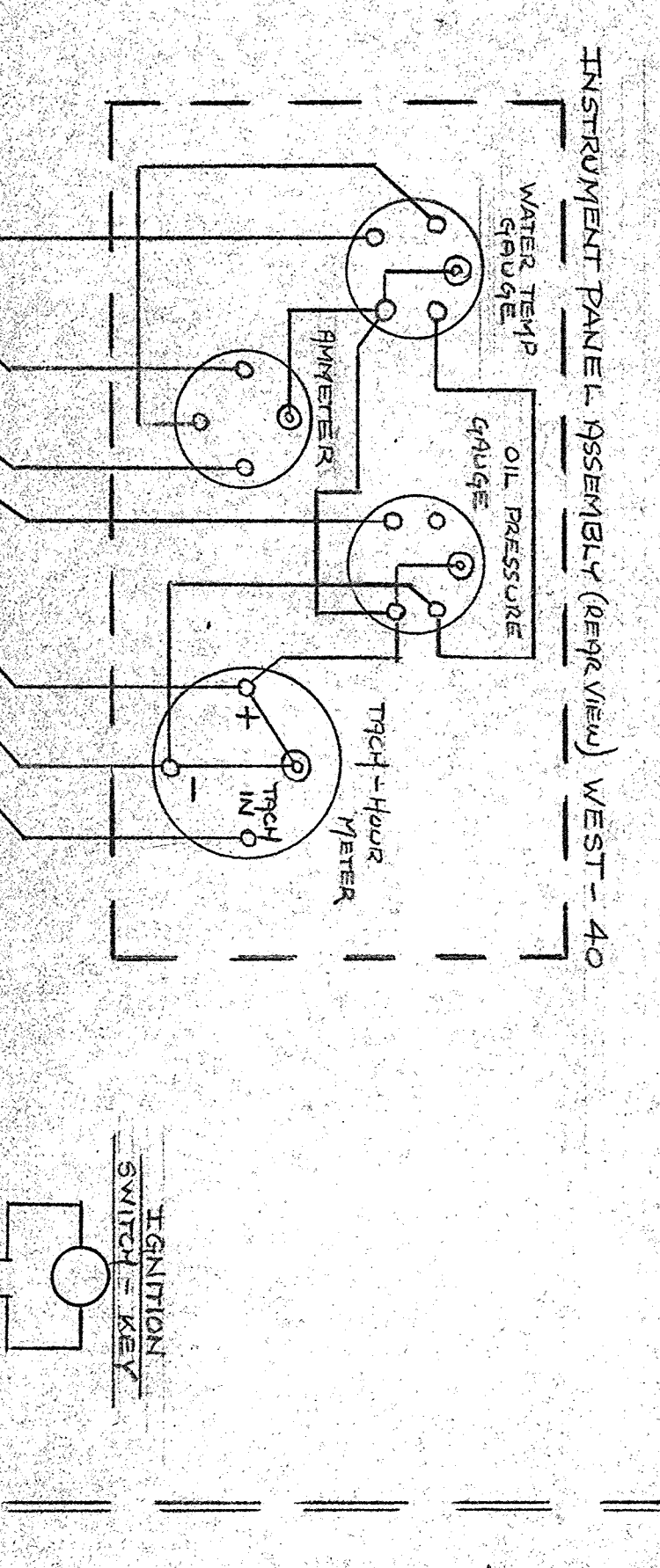
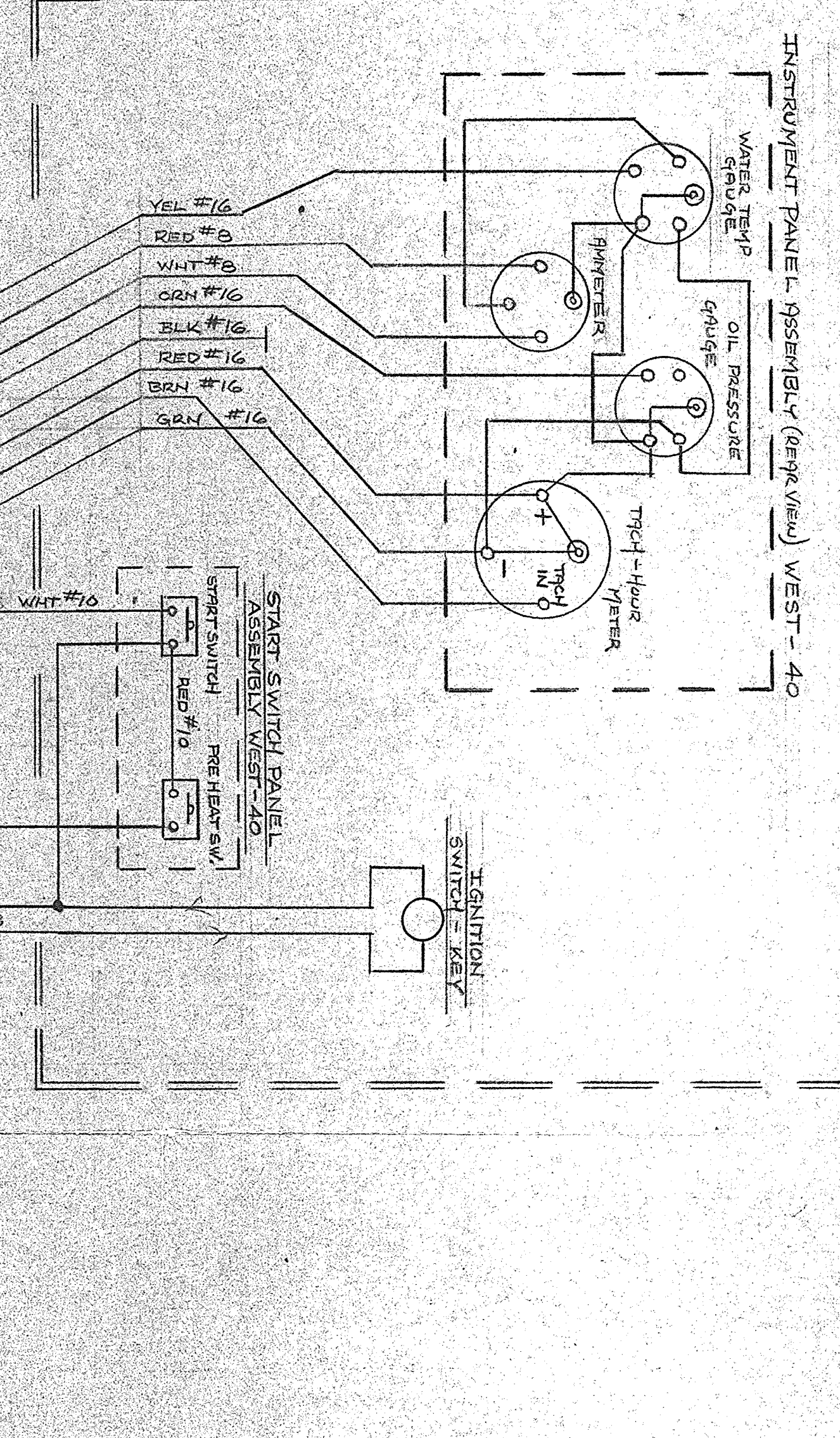

GENERAL NOTES

- A. Boat to be wired in accordance with the electrical section of our Engineering Specifications, Sections 9-7 and 9-8.
- B. Circuits and the items that they include.
  1. THE "DECK LIGHTS" CIRCUIT INCLUDES STEREO LIGHTS AND/OR "DECK FLOOD LIGHTS".
  2. THE "CABIN LIGHTS" CIRCUIT INCLUDES THE FOLLOWING ITEMS:
    - a. PORT COASTWAY LIGHT
    - b. CABIN LIGHT, SMALL
    - c. REARWARD TUBE LIGHT TWO OR C. CABIN LIGHT, LARGE
    - d. REARWARD LIGHT
    - e. DOWN LIGHT
    - f. BOW LIGHT
  3. "RUNNING LIGHTS" INCLUDES THE FOLLOWING: PORT AND STERBOARD RUNNING LIGHTS, STEERBOARD FORWARD AND AHEAD LIGHTS, REVERSE LIGHT.
  - C. ELECTRICAL, CONTROL AND LIGHTING DIAGRAMS: P-2567 ELECTRICAL PANEL P-2587
  - D. ANY DEVIATION FROM THIS WIRE COLOR CODING DUE TO SPECIFIC WILL BE DOCUMENTED WITH A COPY INCLUDED IN THE OWNER'S KIT.

REV	DESCRIPTION	BY	APPR.	DATE
A	OPTIONAL AC CONVERTING WIRE CHANGES FROM 2/2 TO 1/2. WIRING FROM INSTRUMENT ASSEMBLY CHANGES FROM 2/2 TO 1/2. A.C. COASTWAY SELECTOR CHANGES FROM 2/2 TO 1/2. WIRING FROM INSTRUMENT ASSEMBLY CHANGES FROM 2/2 TO 1/2. WIRING FROM INSTRUMENT ASSEMBLY CHANGES FROM 2/2 TO 1/2. WIRING FROM INSTRUMENT ASSEMBLY CHANGES FROM 2/2 TO 1/2.	JS		1-25-75

ITEM NO.	QTY	PART NO.	DESCRIPTION	MATL. SPEC.	STOCK SIZE
BILL OF MATERIALS					
BOAT- TYPICAL- 36 FOOT HOUSE SLOOP					
ELECTRICAL WIRING DIAGRAM					
DATE	APPROVED	WKS.	REV		
11/3/75					
SCALE					
P-2563					
REV					
A					

PEARSON YACHTS  
GRUMMAN AERIAL INDUSTRIES, INC.  
PORTSMOUTH, RI